



UNIVERSITÀ  
DEGLI STUDI DELLA  
**Tuscia**

12 giugno 2019

**Bartolomeo SCHIRONE**

## ZEPHYR

Tecnologie innovative a impatto zero per la produzione di piante per uso forestale

# METTIAMOCI IN RIGA



# Zero Impact Innovative Technology in Forest Plant Production



Total Cost: 4,284,275 €

EC Contribution: 3,438,252 €

Duration: 36 months

Start Date: 01/10/2012

End of the Project: 01/10/2015

Consortium: 14 partners from 10 countries

Project Coordinator: Tuscia University – DAFNE Department (Italy)





# PROJECT PARTNERS

Dept. DAFNE, Tuscia University - IT	IT
DEMOCRITUS UNIVERSITY OF THRACE	GR
CO.MET.ART. SAS	IT
VALOYA OY	FI
ROBOSOFT SA	FR
VIVAI TORSANLORENZO Società Agricola	IT
FRAUNHOFER IFAM	DE
ACREO AB.	SE
HOGSKOLAN DALARNA	SE
VELTHA IVZW	BE
INSUBRIA University	IT
ADVANTIC SISTEMAS Y SERVICIOS	ES
AZORINA SA	PT
EXERGY LTD	UK





# CLIMATE CHANGE: GLOBAL WARMING PROJECTIONS

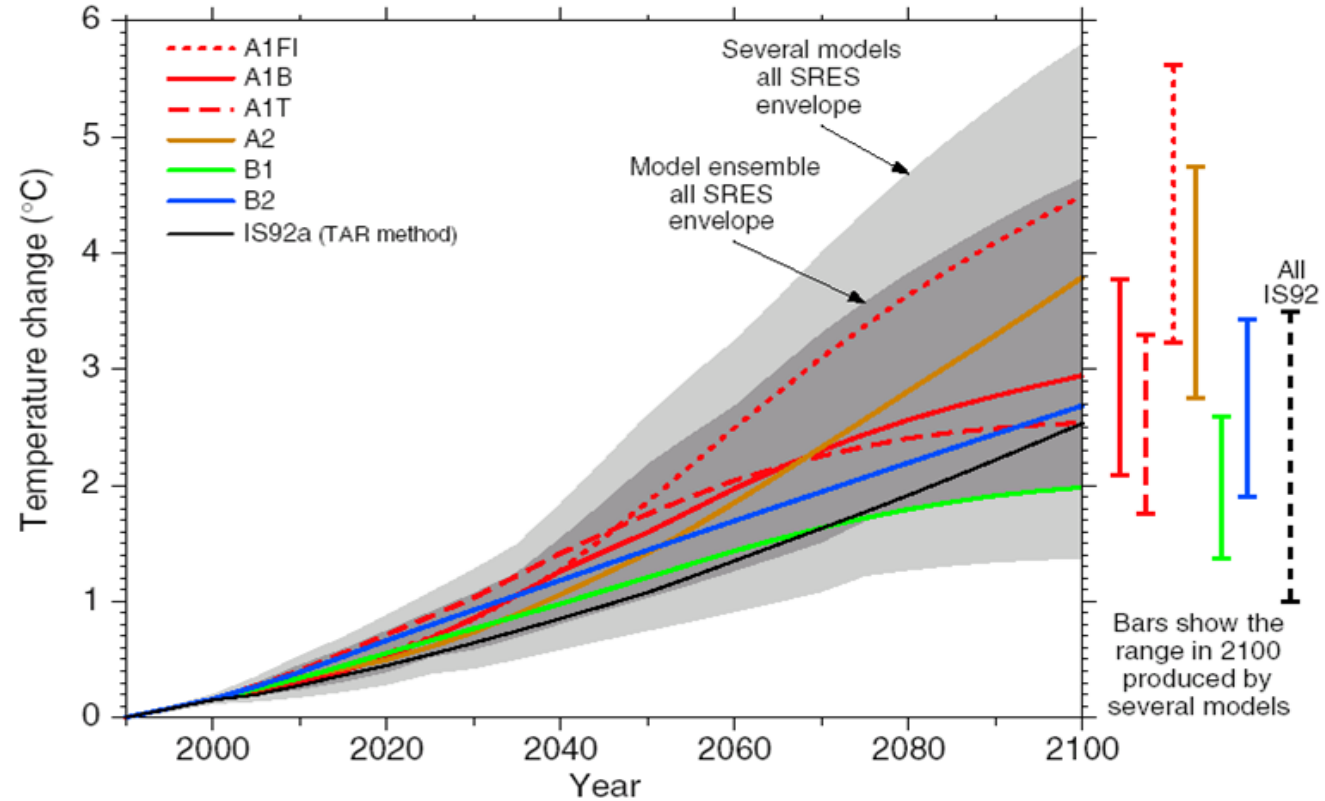



Climate change and over-exploitation of the earth resources by humans are causing a major increase of environmental disasters (floods, large fires, etc..) and a progressive loss of fertile soil and of fresh water reserves.





Soil degradation, including soil erosion, salinization and land drying due to overgrazing, concerns quite all the world lands.

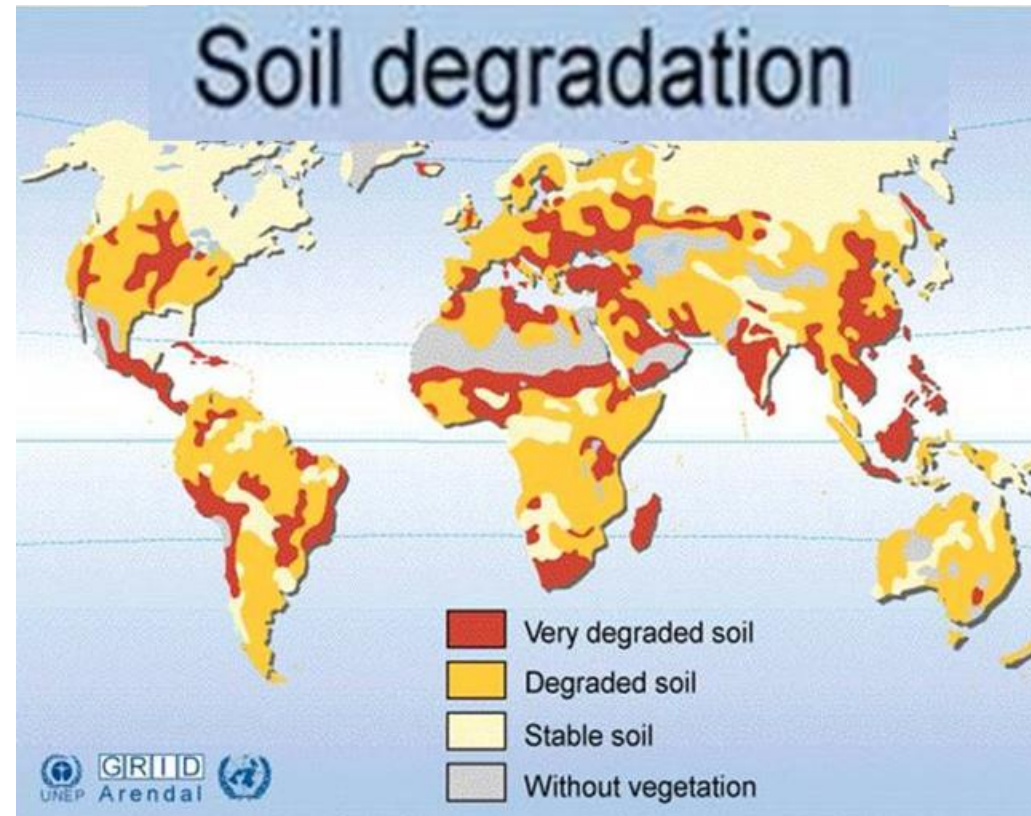



To face the decrease of arable land, in the agricultural sector, they are now more and more spreading large plant factories ...





... and the architects are planning real skyscrapers for the production of plants for human nutrition







On the other hand, the problem of soil degradation concerns also the forest areas, the 'lungs' of the earth. And the loss of forest ecosystems and their biodiversity can affect the very life of people on the planet.





The reduction of arable lands and forests requires a more and more sustainable management of natural resources, water and energy. This is also the basic concept of the circular economy

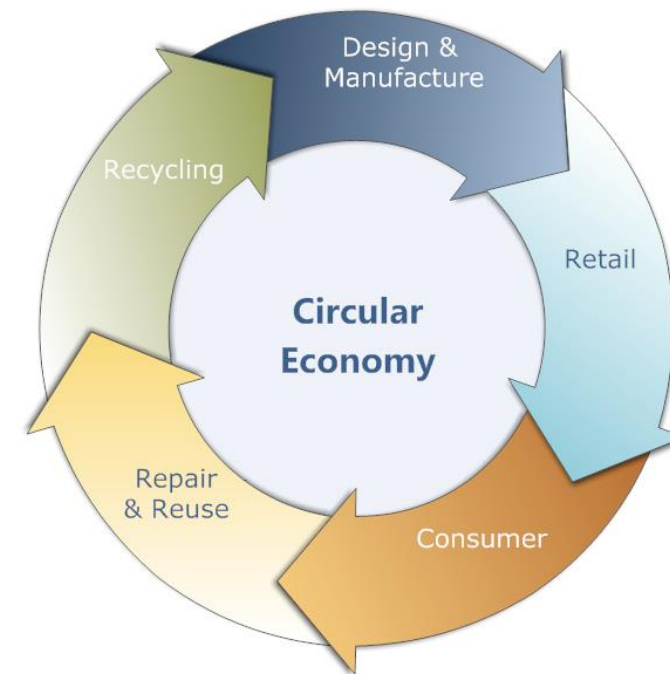



In forest restoration activities, the production of seedlings for reforestation is highly expensive in terms of space, water, energy and other resources.



*Germination and early growth*



Irrigation and fertilization



Large container stock



Outdoor growth



Starting from these assumptions, Zephyr project aims to contribute to an efficient and sustainable production of plantlets for environment restoration purposes. In particular, we are trying to apply the concept of plant factory also to forest plants. After several national and European projects, such as Pre-Forest and Regen-forest, we arrived to Zephyr approach.

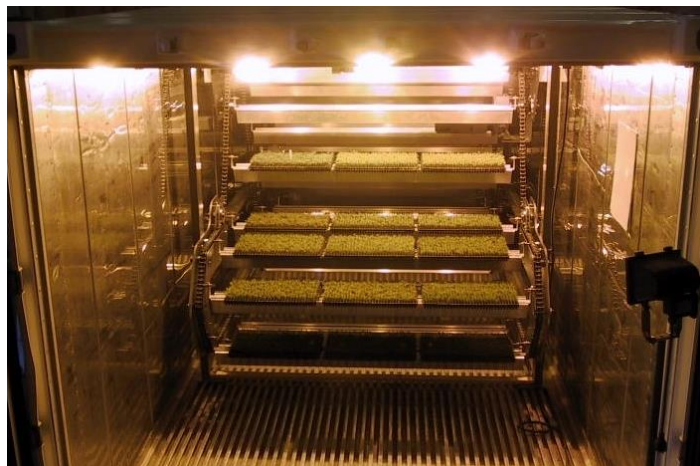



Zephyr proposes a new concept of forest nursery. In fact, the final product of Zephyr project is a transportable, energy saving and autonomous growth chamber, totally robotized, that can be considered as the basal unit of a new kind of plant factory. In fact, it is possible to design a plant factory by adding many Zephyr units.



ZEPHYR  
PROTOTYPE





# Zephyr Project: Engineering

The prototype design has taken into account the most advanced systems to save energy and recycle a valuable resource such as water.

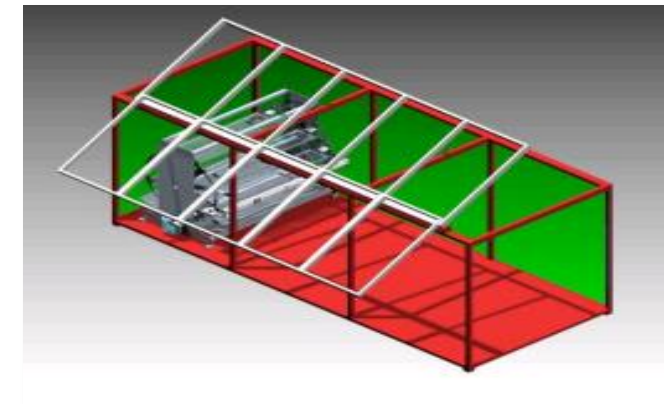

31 x 53 cm

QP D 104 VW

		104	(8x13)
		630/m <sup>2</sup>	
		310x530 mm	





# Zephyr Project: Design of the sensors

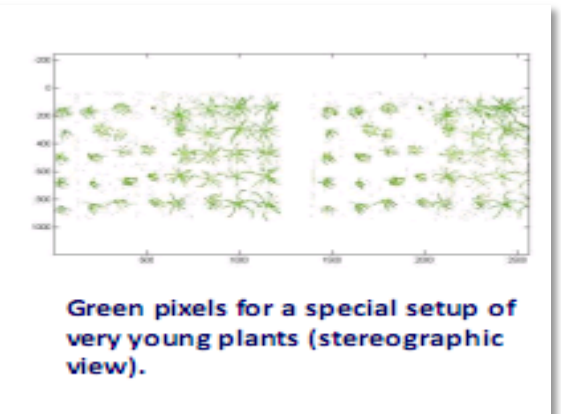
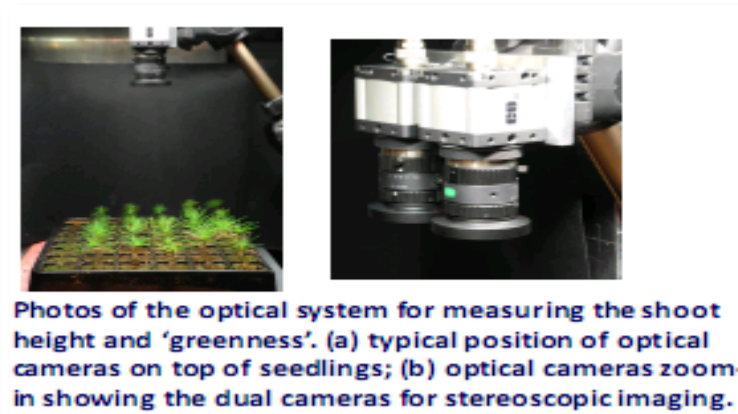
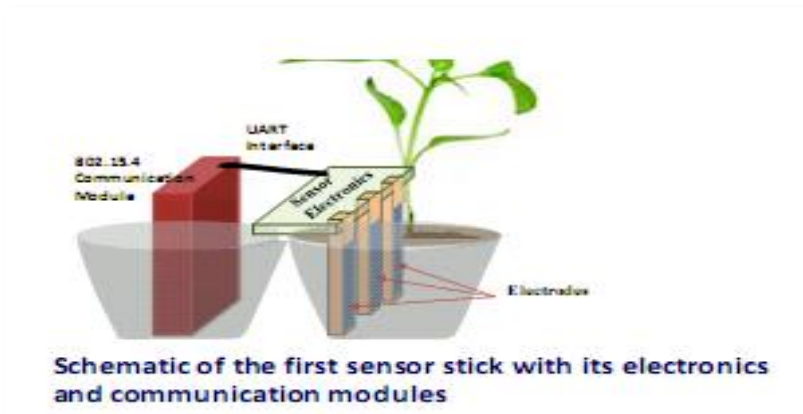
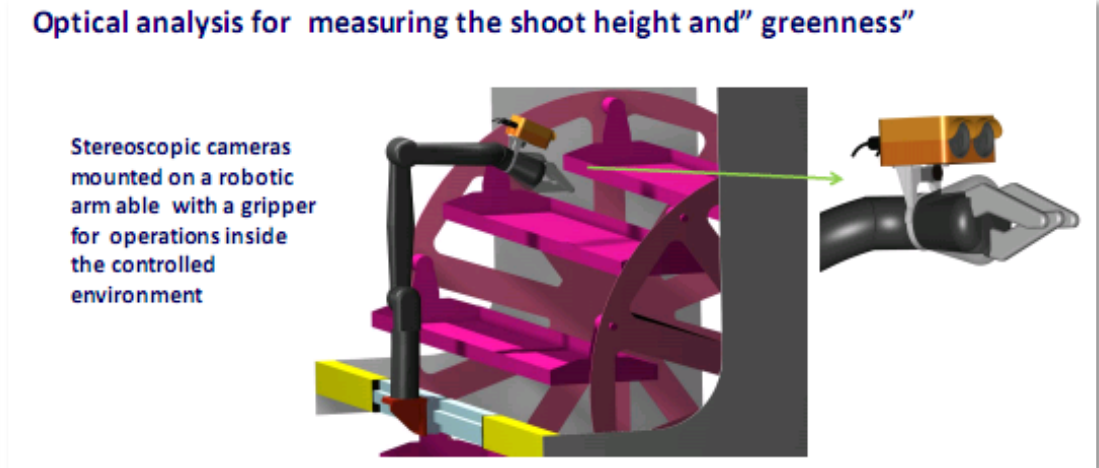
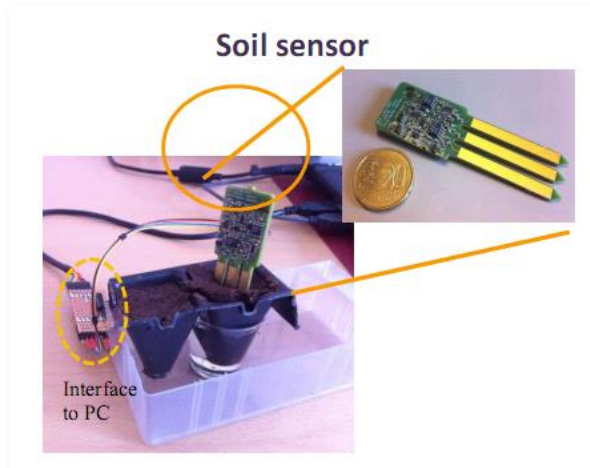



## ZERO Impact Innovative technology in Forest Plant Production Plant factory mobile per la coltivazione di specie forestali

- Tamburo rotante (10 ripiani)
- Sistema di condizionamento dell'aria
- Sistema di irrigazione ebb&flood
- Braccio robotico
- Sensori wireless (per monitorare il substrato)
- Sensori ottici

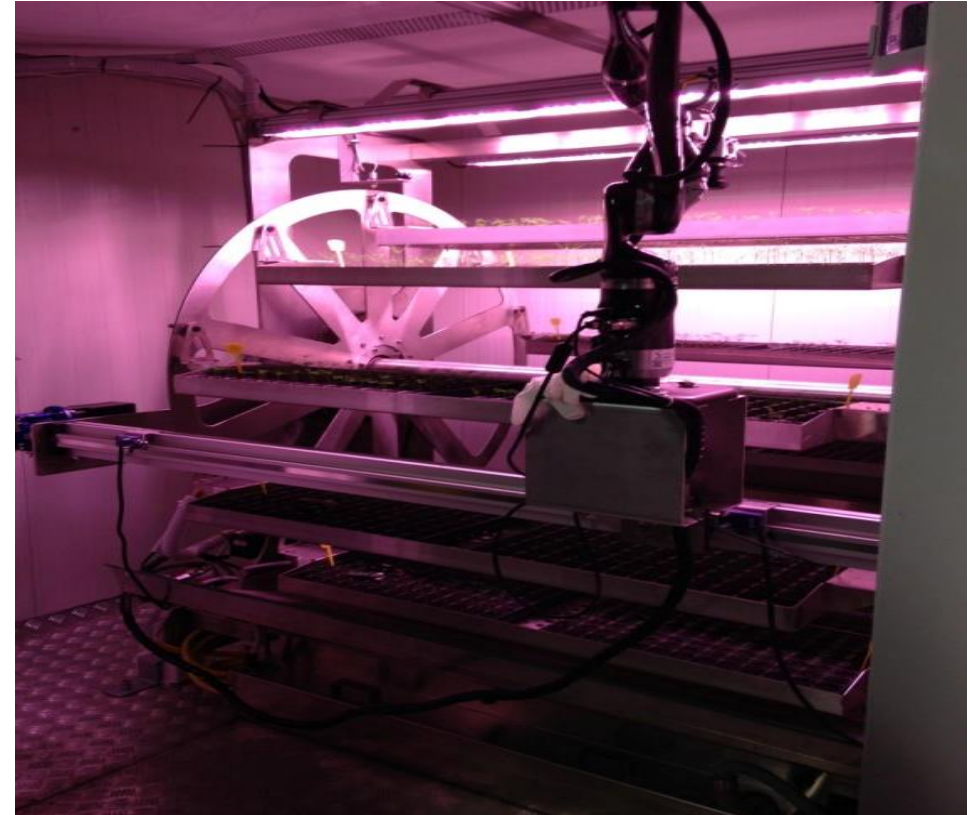







# Differences between horticultural and forest plants

The first problem that Zephyr had to deal with was one of the conservation of forest biodiversity that ensures best adaptation to environmental changes. The forests, unlike the agricultural crops, are not simple sets of plants, but complex systems that can survive and evolve spontaneously only if the genetic variability of the trees is safeguarded. This is achieved by producing plants from seed and not from cuttings.





# LED = Light Emitting Diode (diodo ad emissione di luce)

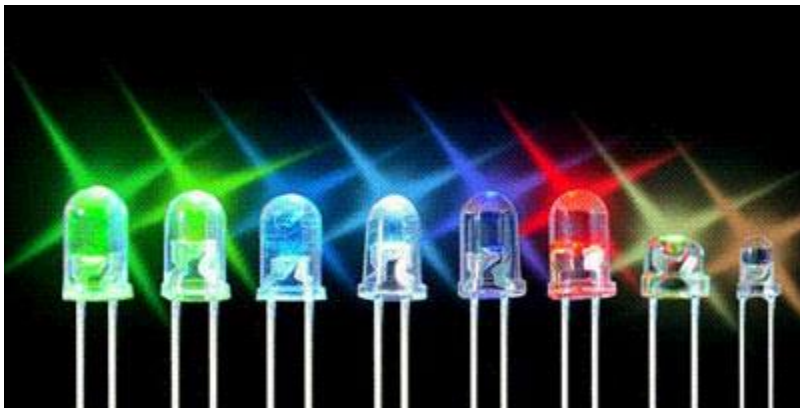

La scelta del semiconduttore  
determina la lunghezza d'onda  
d'emissione



Infinite combinazioni di singoli LED -> creazione di  
infiniti spettri continui (400-1100 nm)

**Fonte luminosa più idonea per *replacement lighting***



# Light Spectrum

The light spectra depend on the photoperiod and the light intensity but also on the tree cover (difference in height species and density)

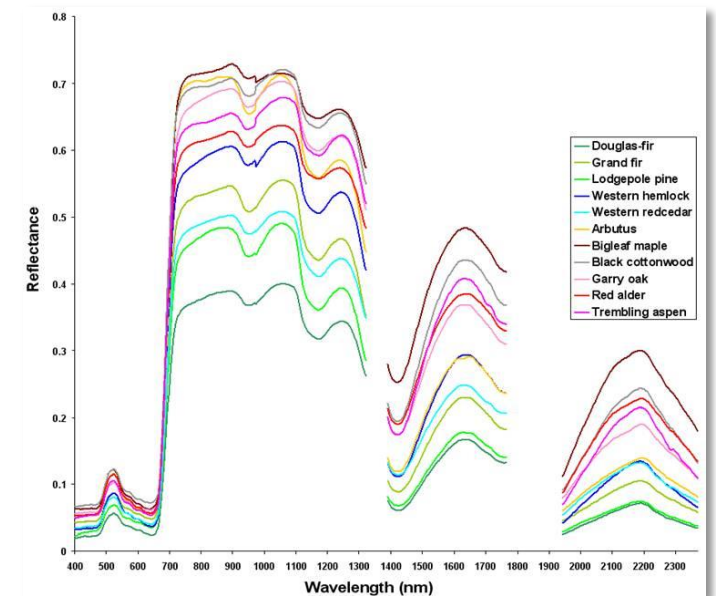
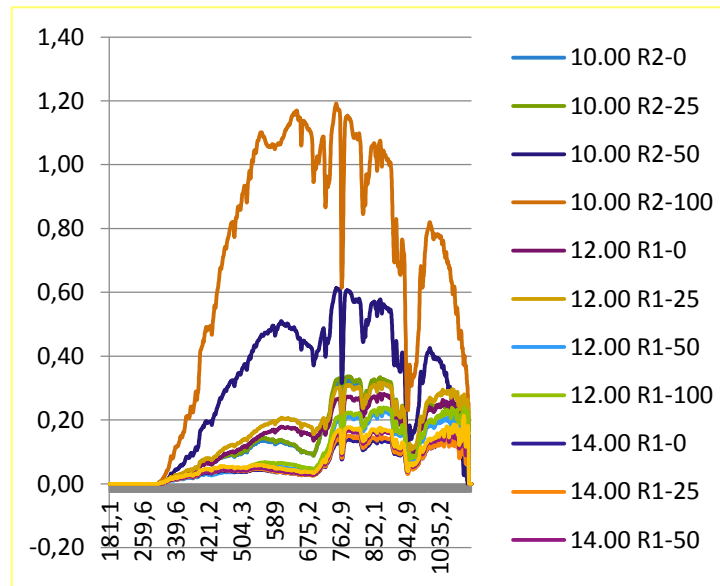



# Zephyr Project: bio-ecological studies

To achieve this goal, the project has involved long and complex bio-ecological studies in the field and laboratory, especially to determine the most efficient light sources

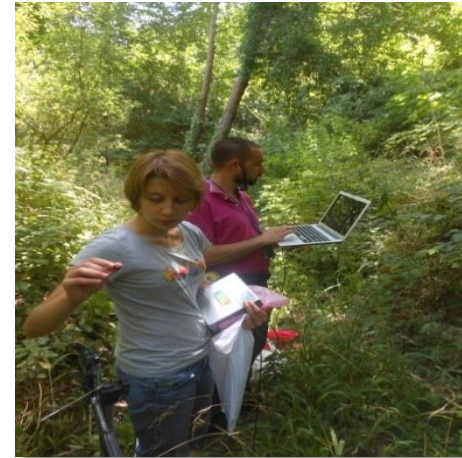

# Task 3.3 Growth tests performed in normal growth chambers with LED lamps (Task leader UNITUS)



The new LED lights provided by Valoya® have **low PAR intensity** if compared to sunlight and almost totally absence of **UV** (< 400 nm) and **INFRARED** light (> 700 nm)

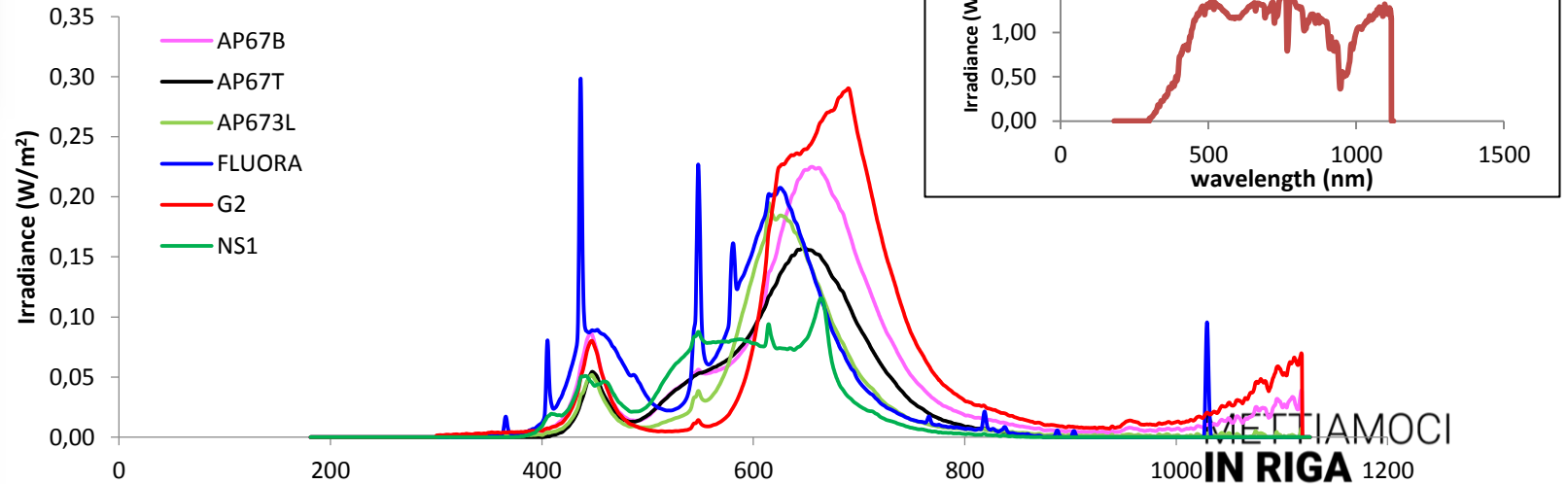
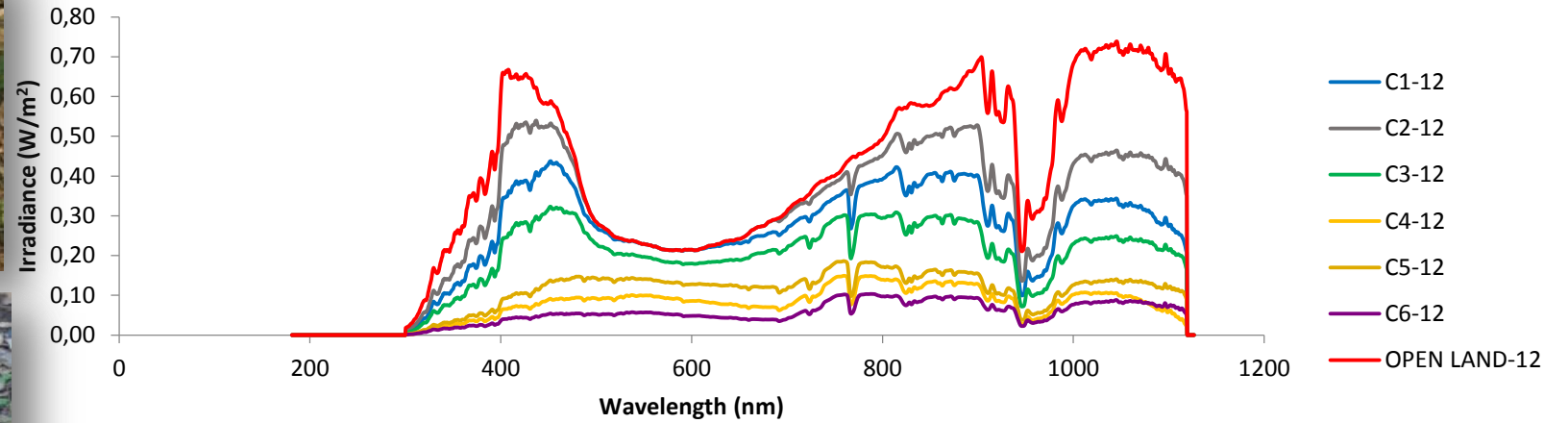

METTIAMOCI IN RIGA



# Task 3.3 Growth tests performed in normal growth chambers with LED lamps (Task leader UNITUS)

## Different LED light sources tested

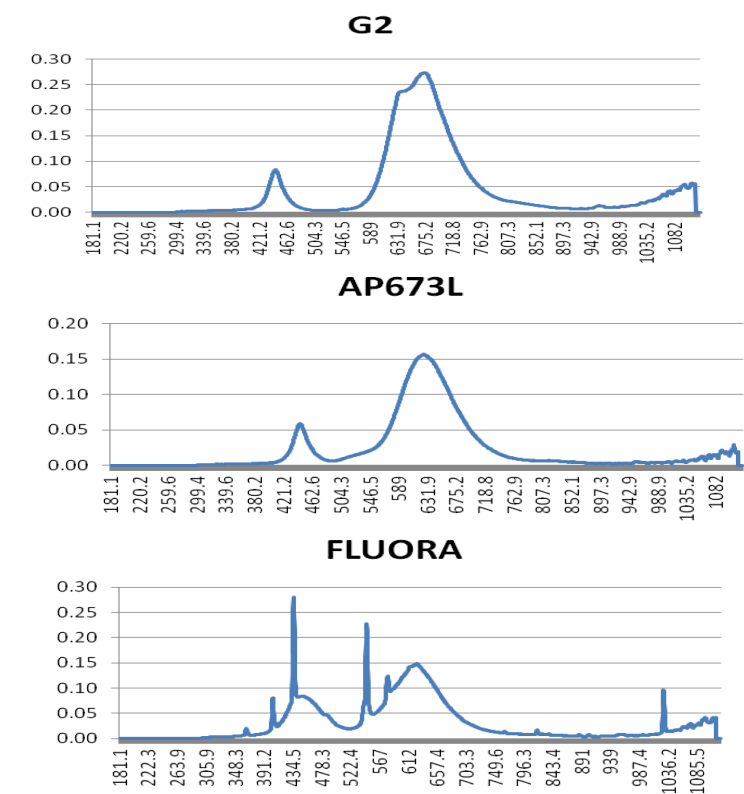
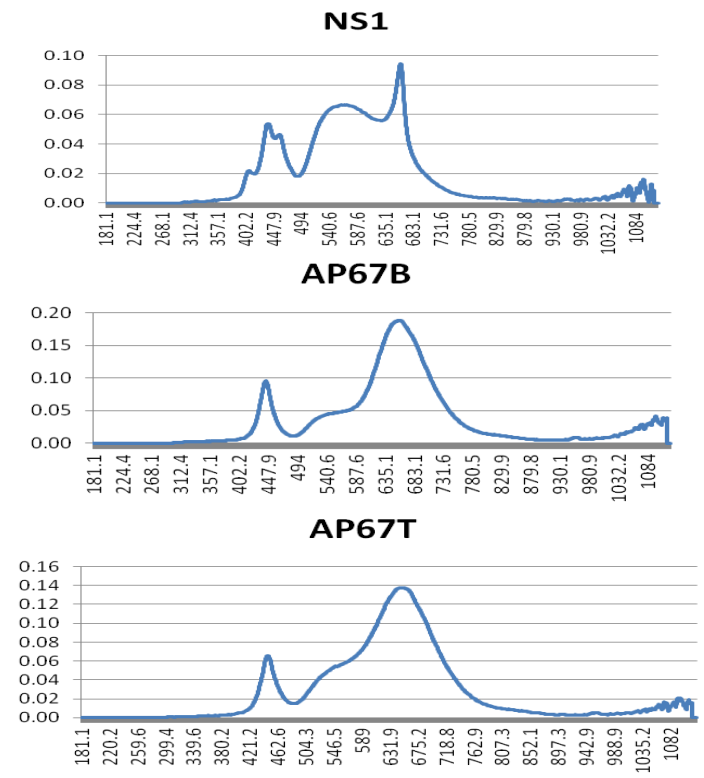



# Zephyr Project: The research on light sources

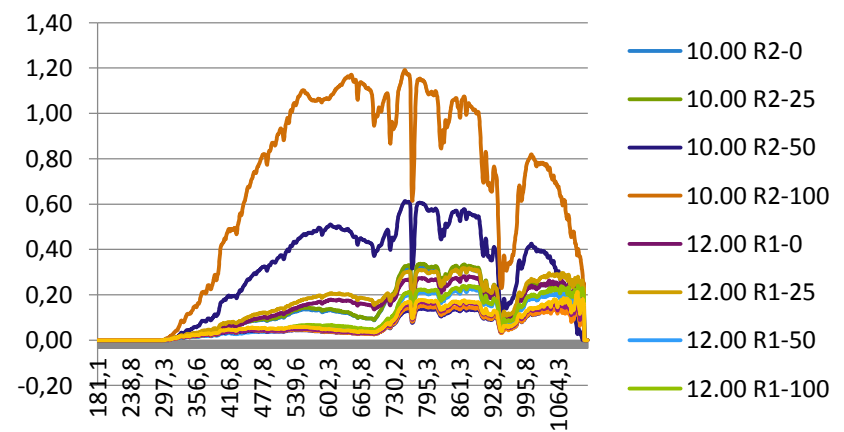
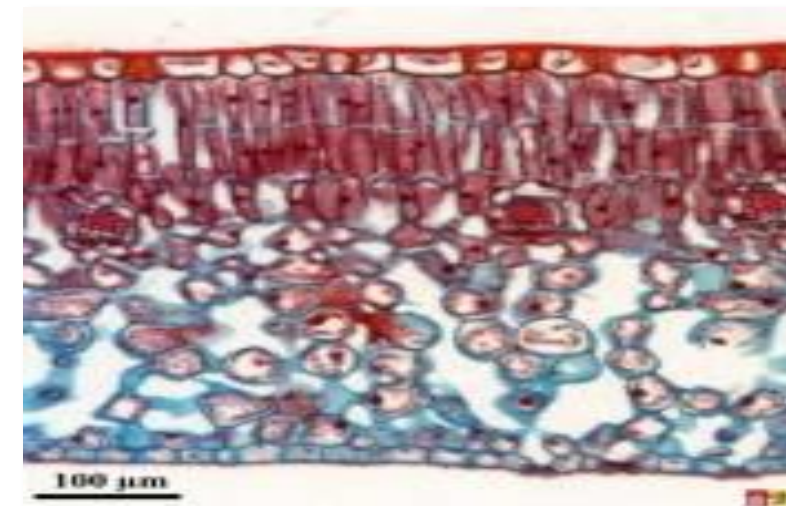
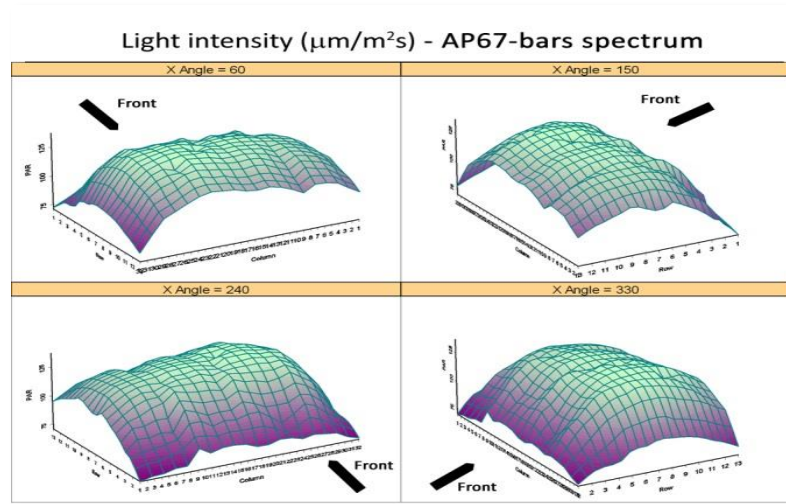

24

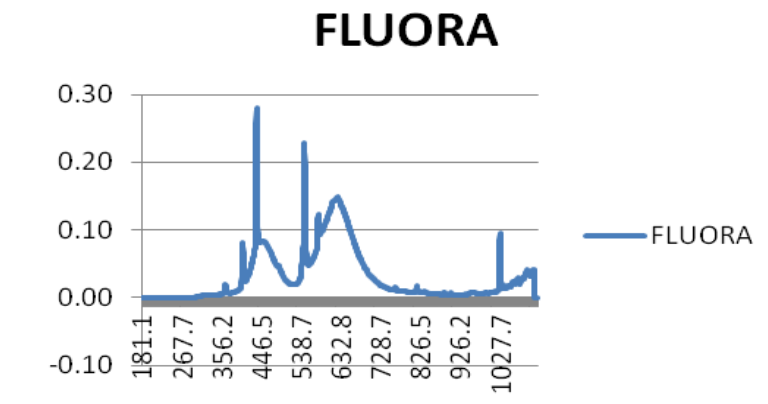
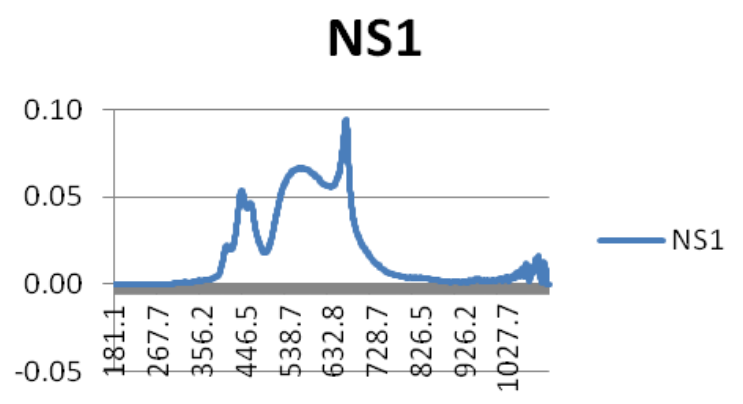

METTIAMOCI  
IN RIGA





# Zephyr Project: The research on light sources

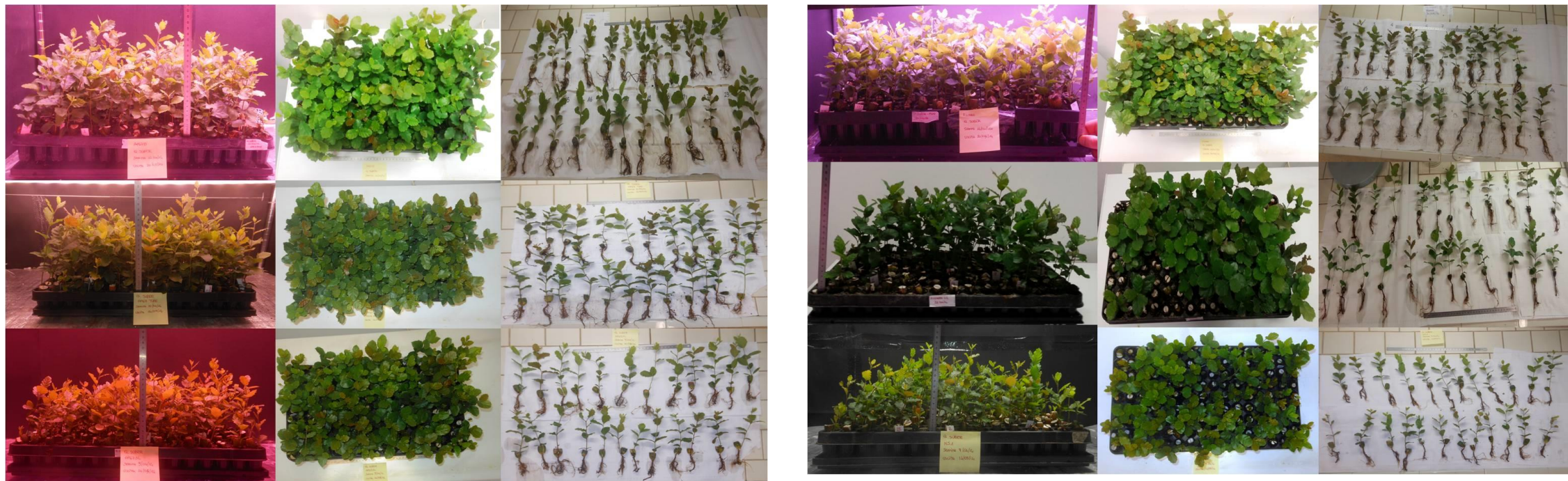



# Analisi morfometriche:

Altezza del fusto

Diametro dello stelo

Numero di foglie

Peso fresco (e secco) dello stelo

Peso fresco (e secco) delle radici

Peso fresco (e secco) delle foglie

Area fogliare

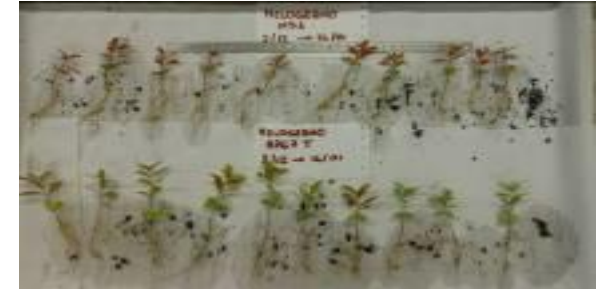



# Analisi microscopiche:

Densità e dimensioni degli stomi

Sezioni trasversali foglia

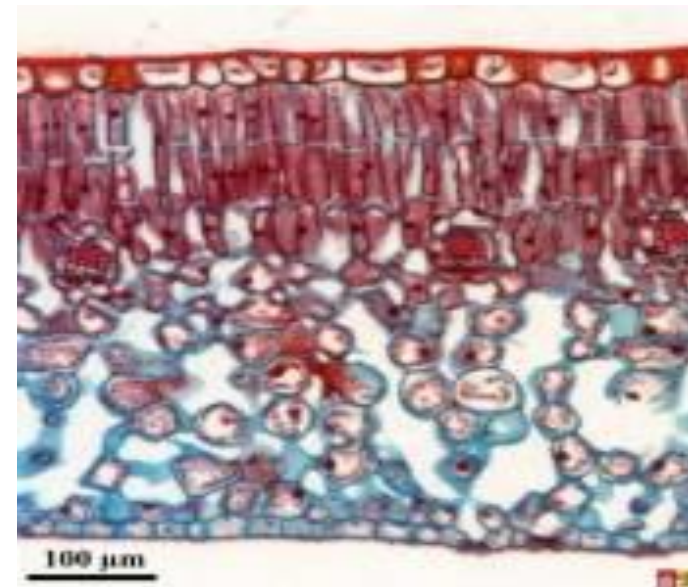
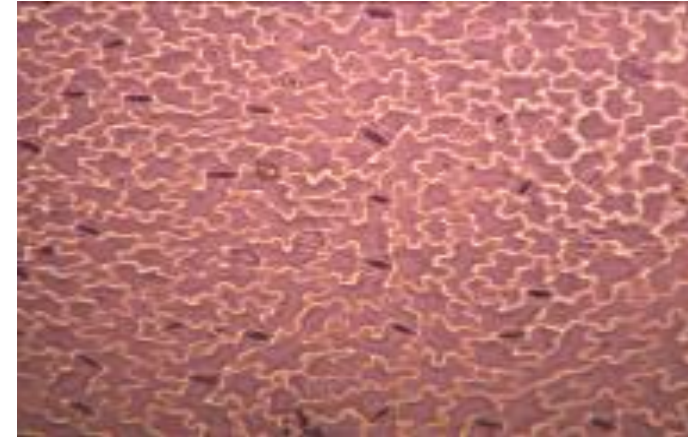



# Analisi biochimiche:

SPAD

Contenuto proteine

Attività enzimatica GS

Attività enzimatica NR

Perossidazione dei lipidi

Contenuto di clorofilla a, b

Contenuto di carotenoidi



## Task 3.4 Growth tests with the new sensors (Task leader UNINSUBRIA)

**Non-destructive analysis:** Greenness measurement and Plant height

**Greenness (%)** was estimated as percentage of shoot cover projected on tray ground and data were obtained with optical sensors (*Dualcam* - ACREO)

**Plant height** was manually taken during the growth period to find a relationship with plant biomass, and furthermore, compared with data obtained from images acquired by optical sensors and analysed by *uEyeDualcam* and *HeightMap* softwares (ACREO)

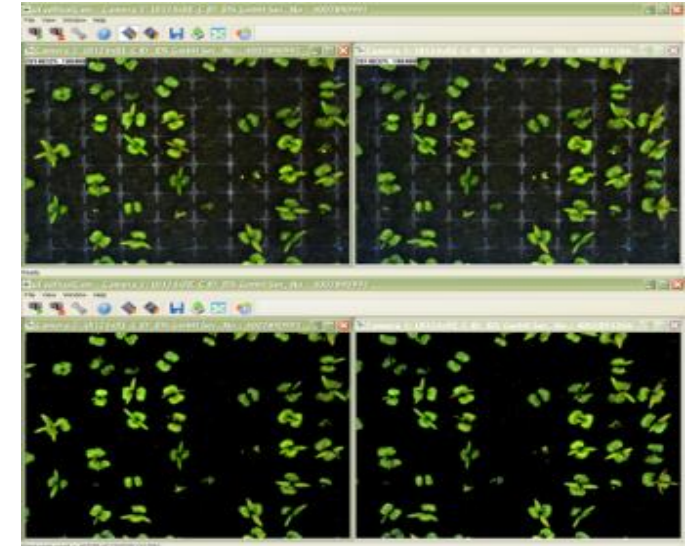

Images of greenness analysis for Pomegranate (*uEyeDualCam* software)

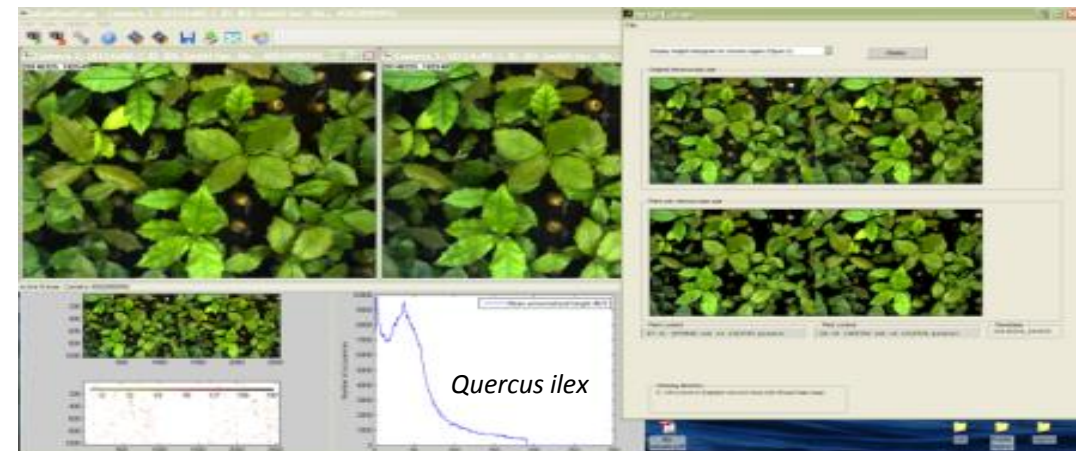

Above, stereoscopic photo of Holm oak plant tray. Below, Height map and Height histogram obtain by *Height MAP* software analysed



# Task 3.4 Growth tests with the new sensors

(Task leader UNINSUBRIA)

## Height analysis

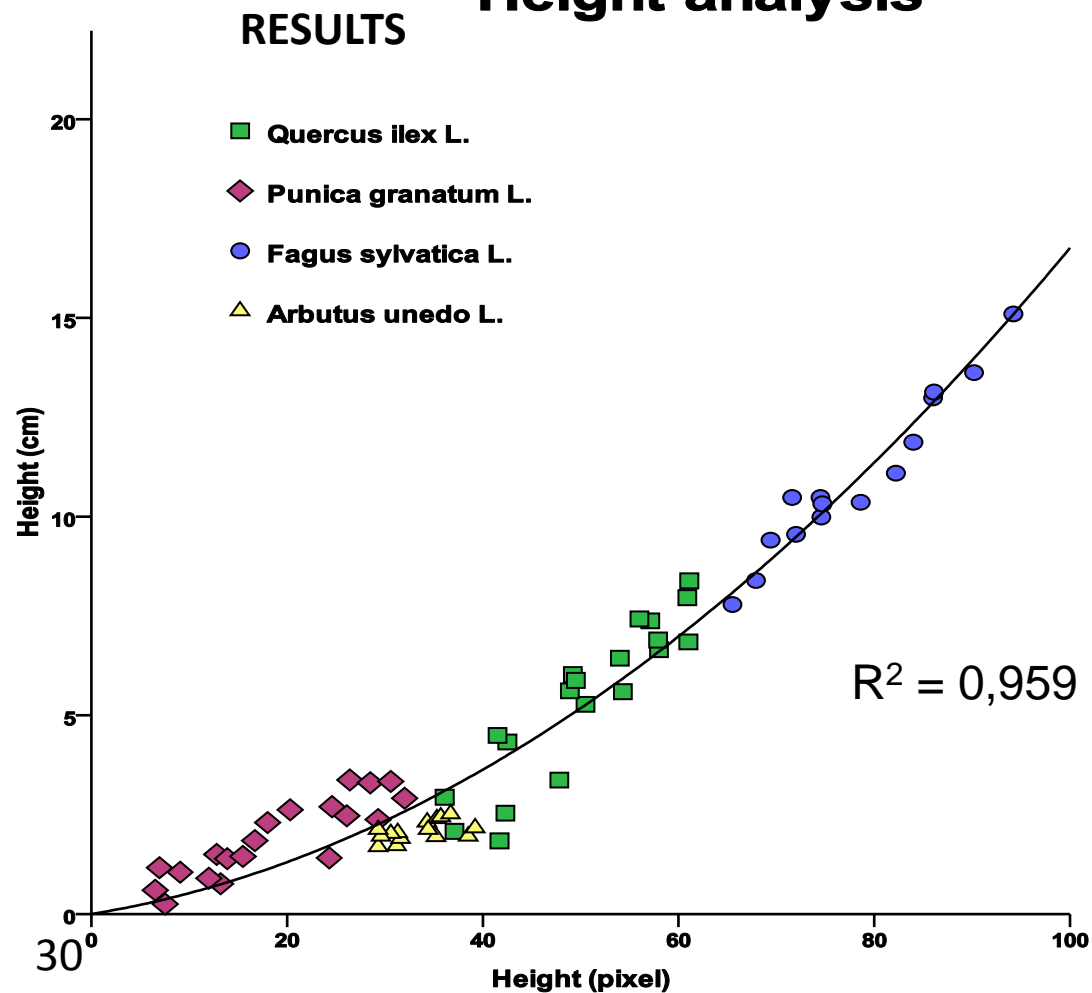

Optical sensors

- 4 new species were tested

- Softwares are able to follow the growth of different species (different plant height and leaf color)



# Task 3.2 Implementation of the new growth protocols (Task leader DU)



**From the growth chamber  
to the field trials**





# The tests on Zephyr forest plants

The first results of the cultivation tests on forest plants in the laboratory, greenhouse and field using the protocols developed for the prototype Zephyr are very promising.

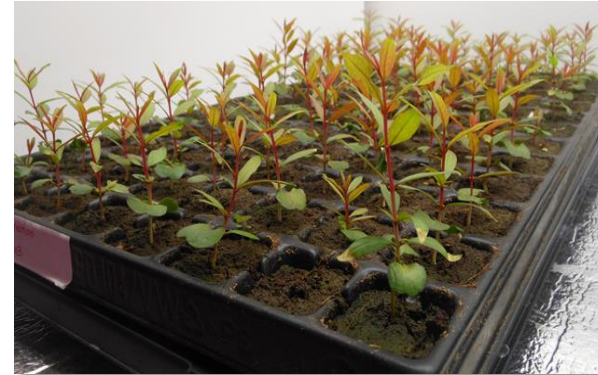





# Specie oggetto di studio

1. *Abies alba* Mill.
2. *Arbutus unedo* L.
3. *Arctostaphylos uva-ursi* L.
4. *Azorina vidalii*
5. *Castanea sativa* Mill.
6. *Cornus sanguinea* L.
7. *Corylus avellana* L.
8. *Crataegus monogyna* Jacq.
9. *Fagus sylvatica* L.
10. *Frangula azorica*
11. *Fraxinus excelsior* L.
12. *Fraxinus ornus* L.
13. *Hypericum foliosum* Aiton
14. *Juniperus brevifolia* (Seub.) Antoine
15. *Myrtus communis* L.

16. *Picea abies* L.
17. *Pinus nigra* J.F. Arnold
18. *Pinus sylvestris* L.
19. *Platanus orientalis* L.
20. *Populus nigra* L.
21. *Prunus avium* L.
22. *Prunus azorica* L. ssp. *azorica* (Mouillefert) Franco
23. *Punica granatum* L.
24. *Quercus ilex* L.
25. *Quercus ithaburensis* var. *macrolepis* (Kotschy) Hedge & Yalt
26. *Quercus suber* L.
27. *Sambucus nigra* L.
28. *Taxus baccata* L.
29. *Vitex agnus-castus* L.

1. *Corylus avellana* L.
2. *Frangula azorica* Grubov
3. *Fraxinus excelsior* L.
4. *Fraxinus ornus* L.
5. *Hypericum foliosum* Aiton
6. *Laurus azorica* (Seub.) Franco
7. *Morella Faya* (Aiton) Wilbur
8. *Platanus orientalis* L.
9. *Prunus lusitanica* L.  
ssp. *azorica* (Mouillefert) Franco
10. *Quercus suber* L.
11. *Taxus baccata* L.



# PHENOLOGICAL COMPARISON

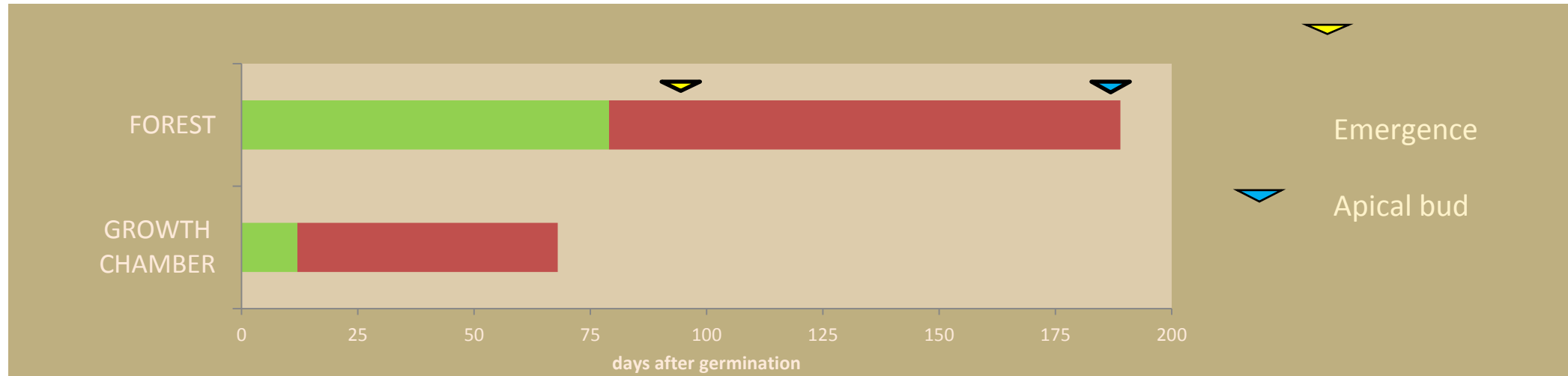

	Forest	Growth chamber	Time reduction (%)
Days between germination and emergence	79	12	<b>84%</b>
Days between germination and apical bud closing	189	68	<b>64%</b>



# Analisi fenologica dei semenzali di sughera in ambiente naturale (bosco), seminaturale (serra) e artificiale (camera di crescita con luci LED)

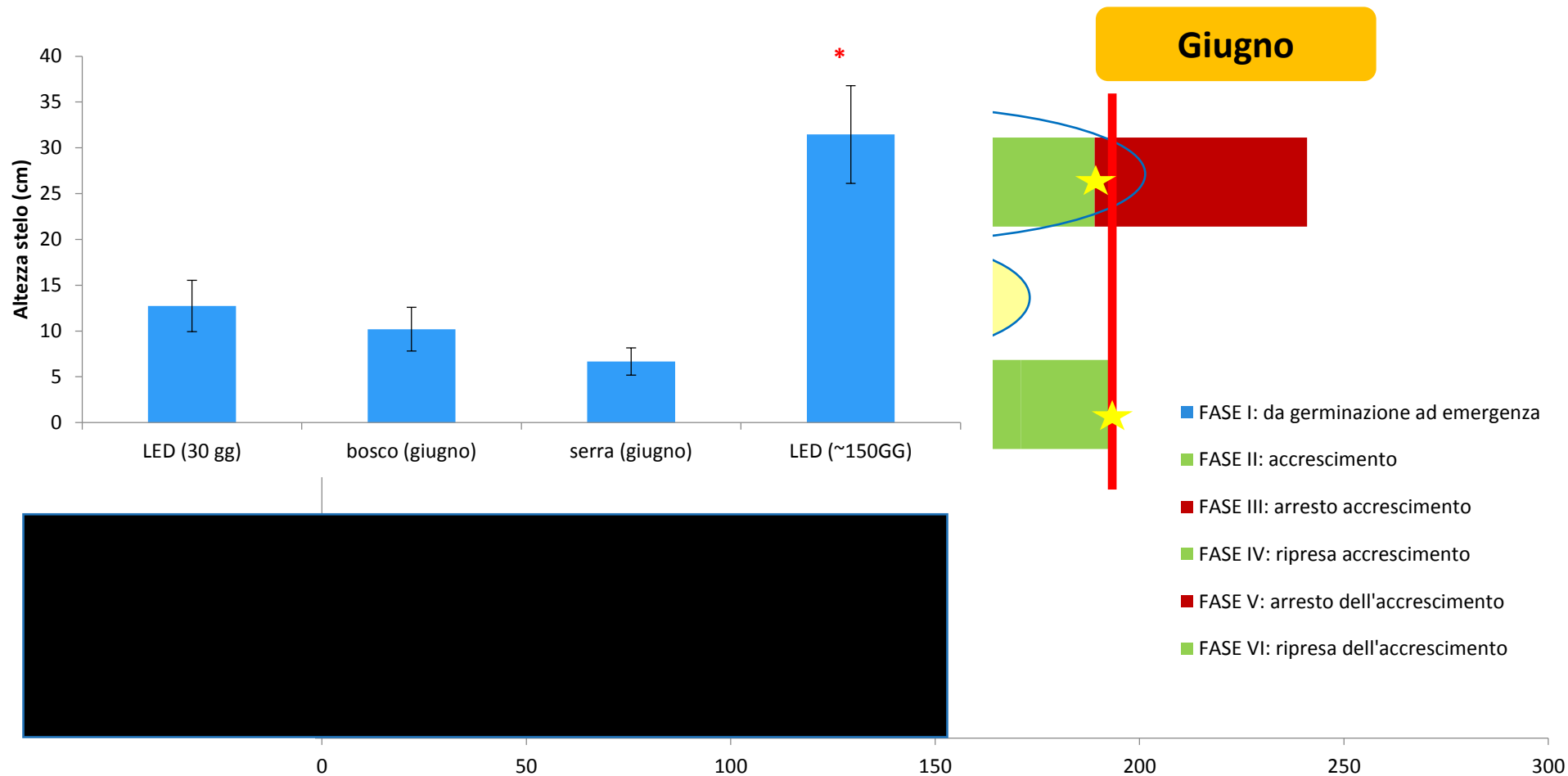

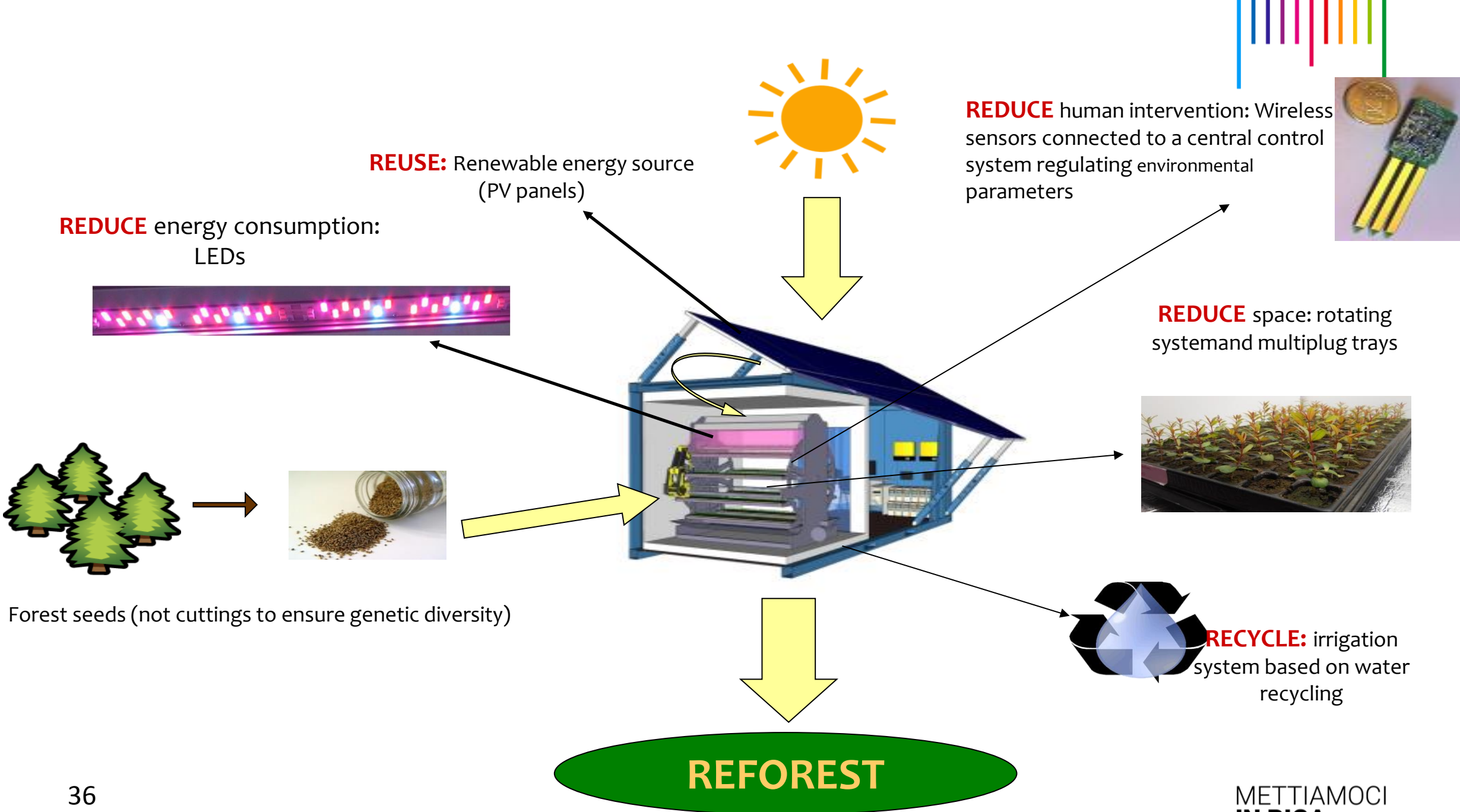

**REUSE:** Renewable energy source (PV panels)

**REDUCE** energy consumption: LEDs

**REDUCE** human intervention: Wireless sensors connected to a central control system regulating environmental parameters

**REDUCE** space: rotating system and multiplug trays

Forest seeds (not cuttings to ensure genetic diversity)

**RECYCLE:** irrigation system based on water recycling

**REFOREST**



# Zephyr Project: Applications

The high quality plantlets produced by Zephyr will be used in reforestation programs and in urban forestry. Probably, the first application of Zephyr approach will be the forest landscape restoration in Azores Islands, where alien species have supplanted the natural vegetation.



*Reforestation*



*Urban forestry*



*Environmental Restoration*



12 giugno 2019

Bartolomeo Schirone

METTIAMOCI  
**IN RIGA**



**GRAZIE**

